

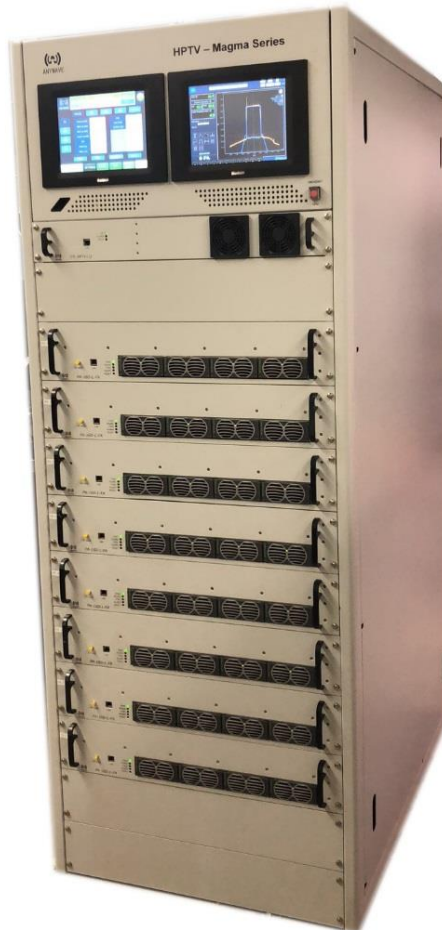

HIGH POWER LIQUID COOLED SOLID STATE VHF BAND I & III TV TRANSMITTER

**REDUNDANT
HOT
SWAPPABLE
POWER
SUPPLIES**



**Up to
20KW IN
A SINGLE
CABINET**

Introduction

The Anywave **MAGMA** series of Liquid Cooled TV transmitters provides the broadcaster with the greatest power density and highest operating efficiencies in digital transmitters today. The **MAGMA** series delivers a broadband solution with peak levels of performance and reliability. These VHF Band I & III Solid State transmitters range in output power from 1.5KW ATSC (1KW OFDM) to 120KW ATSC (80KW OFDM), with up to 20KW ATSC output from a single rack. They operate across all digital TV standards including DVB-T, DVB-T2, ATSC, ATSC3.0, ISDB-T and DTMB. The **MAGMA** series incorporates the powerful correction capabilities of the Anywave digital exciter platforms.



Key Facts

- ✓ Multi-standard capability: DVB-T, DVB-T2, ATSC, ATSC3.0, ISDB-T, DTMB, NTSC, and PAL
- ✓ Implements latest state-of-the-art Asymmetrical Broadband Doherty Technology with Transmitter efficiency up to 45% (VHF III)
- ✓ Modular for better reliability and ease of maintenance
- ✓ Superior Liquid Cooling system incorporates Friction Stir Welded Enhanced Thermal Management and an all stainless steel design
- ✓ Optitune™ technology automatically optimizes performance and efficiency at any power level
- ✓ Redundant hot swappable Power Supply Units
- ✓ Built-in AVQ performance monitoring optional
- ✓ Remote monitoring and control via Web Browser and SNMP



ANYWAVE



General Overview

The Anywave **MAGMA** series implements the latest state of the art devices and technologies, forging a new path in high efficiency, high power, liquid cooled transmitter design. Dual front panel touchscreen monitors provide easy navigation and control as well as detailed operation and performance monitoring of the entire system. With over 450 self-monitoring sensors, the **MAGMA** preventive monitoring system side-steps problems before they occur - providing greater peace of mind.

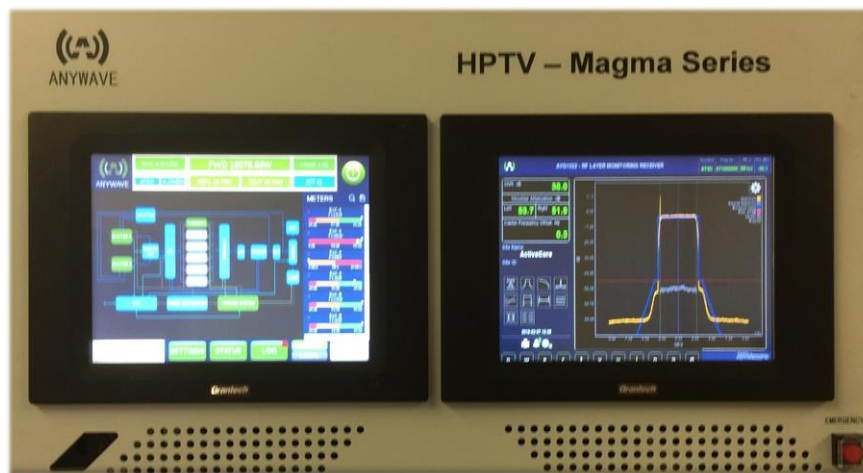

Innovative DDRF™ (Direct Digital RF) broadband automatic balancing technology achieves near perfect RF performance with shoulder levels exceeding -60 dB and out of band spurious also greater than -60 dB, all based on an ultra low noise floor.

The transmitter includes a digital ultra-wideband phase noise processing technology that automatically detects and compensates phase noise to achieve unparalleled performance.



ANYWAVE



20.0 kW ATSC
16.0 kW OFDM



“Magma ... a hot fluid or semifluid material below or within the earth's crust from which lava and other igneous rock is formed by cooling...”

The Magma Series
- forging a new path



ANYWAVE



The Anywave **MAGMA SERIES** - Combine 2 to 6 cabinets to produce up to 120 kW output power.

40.0 kW ATSC
32.0 kW OFDM

120.0 kW ATSC
96.0 kW OFDM



Highest Power Density

- 8 PAs in a single rack provides up to 20kW liquid cooled TX with smallest footprint available today
- Combining up to 6 cabinets produces up to 120 kW output power



ANYWAVE



Intelligent System Design

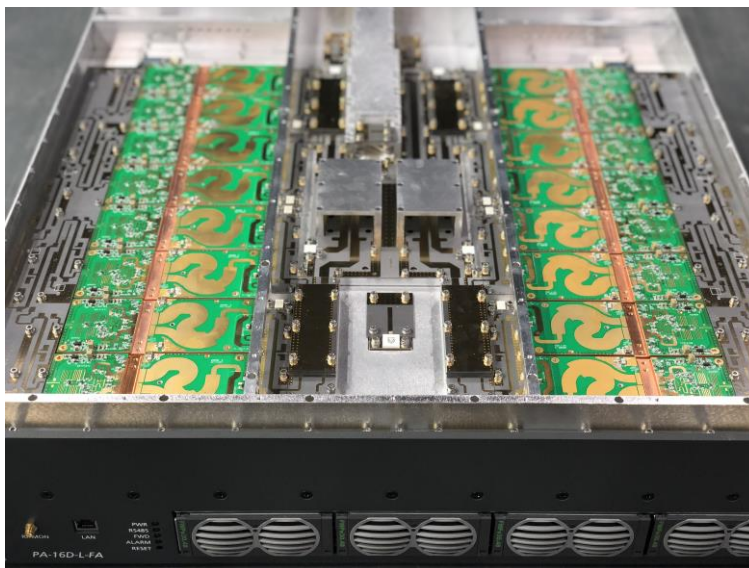
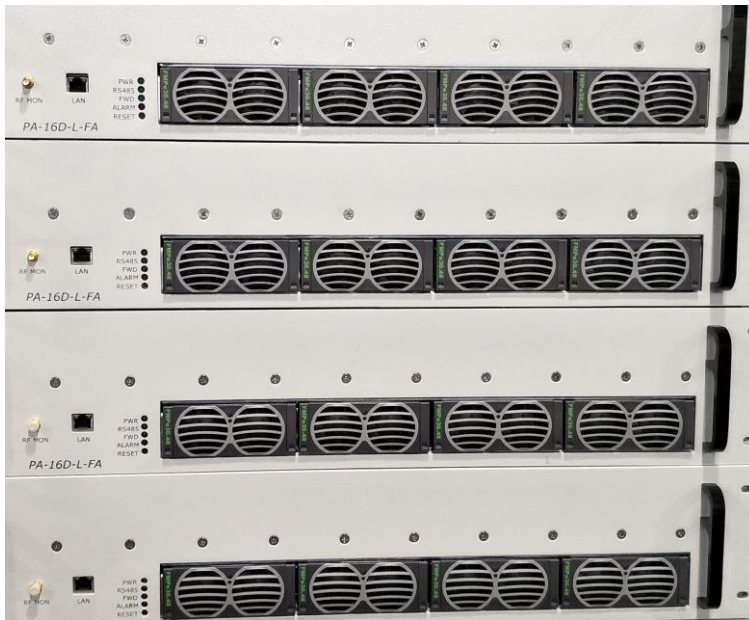

Intelligent Self-monitoring System = Easy to operate

- 4 x 3000W (100% redundant) hot-swappable high-capacity power supplies per PA
- Telco grade AC/DC PSU, self current balancing with variable speed controlled fans
- Redundant & Smart Pumps, Blowers, and Fans operate at reduced optimal levels, even with a failed AC mains phase
- Over 450 self-monitoring system sensors (power levels, voltages, currents, temps, pressures, flows, equipment status, etc.)
- Friction Stir Welding provides best thermal performance - one piece, same material, lower pressure drop - long life, more reliable operation with balanced parallel cooling



ANYWAVE



Optitune™ Technology

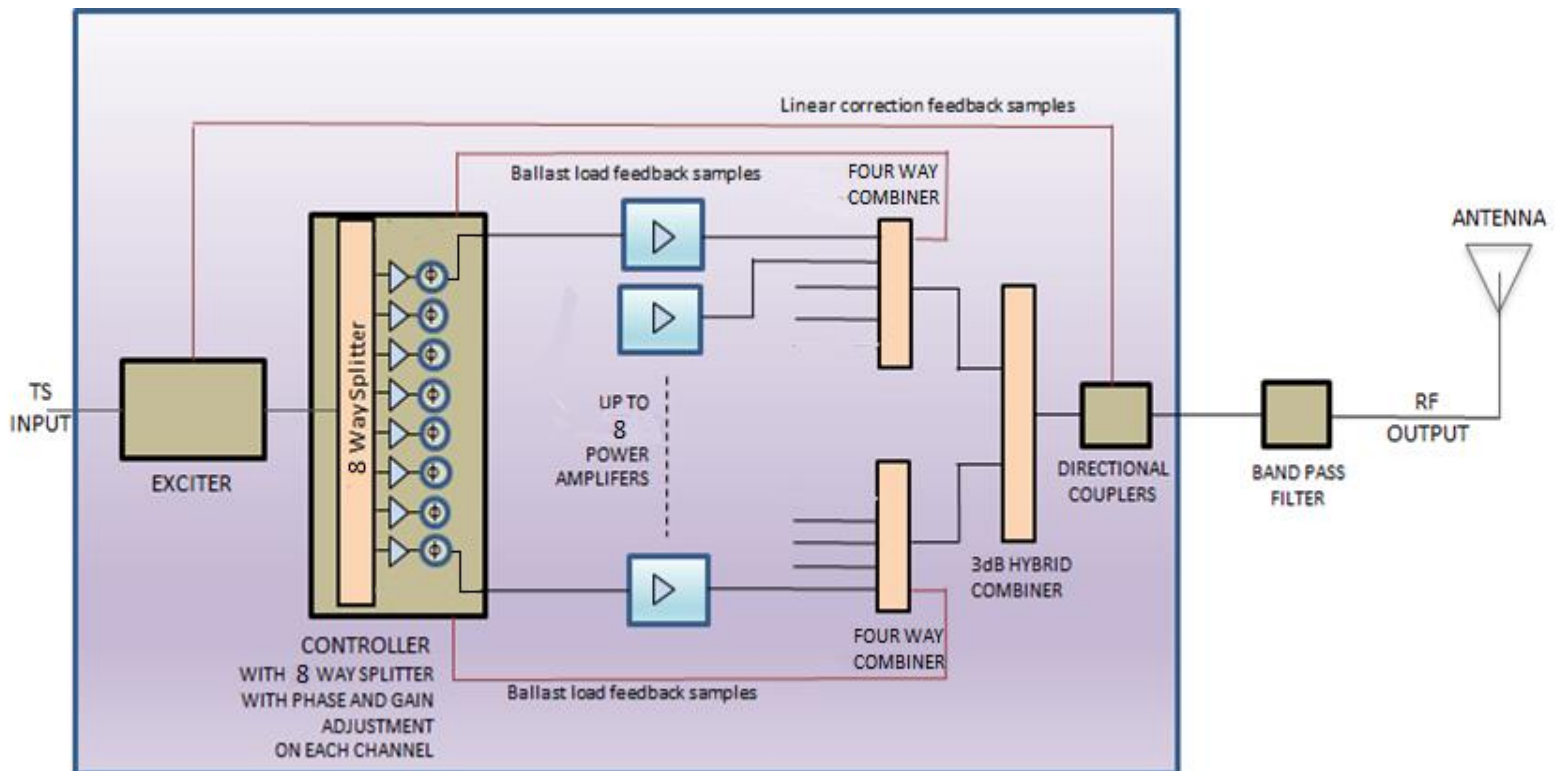

- Self-calibrating, automatic, adaptive phase and gain matching of all PA modules (8 amplifier modules per cabinet, up to 6 cabinets)
- Automatically balances entire system in gain and phase within 10 minutes to achieve maximum output power (minimizes combiner losses) and optimal operating efficiency (minimizes operating costs)



ANYWAVE



AVQ Monitoring

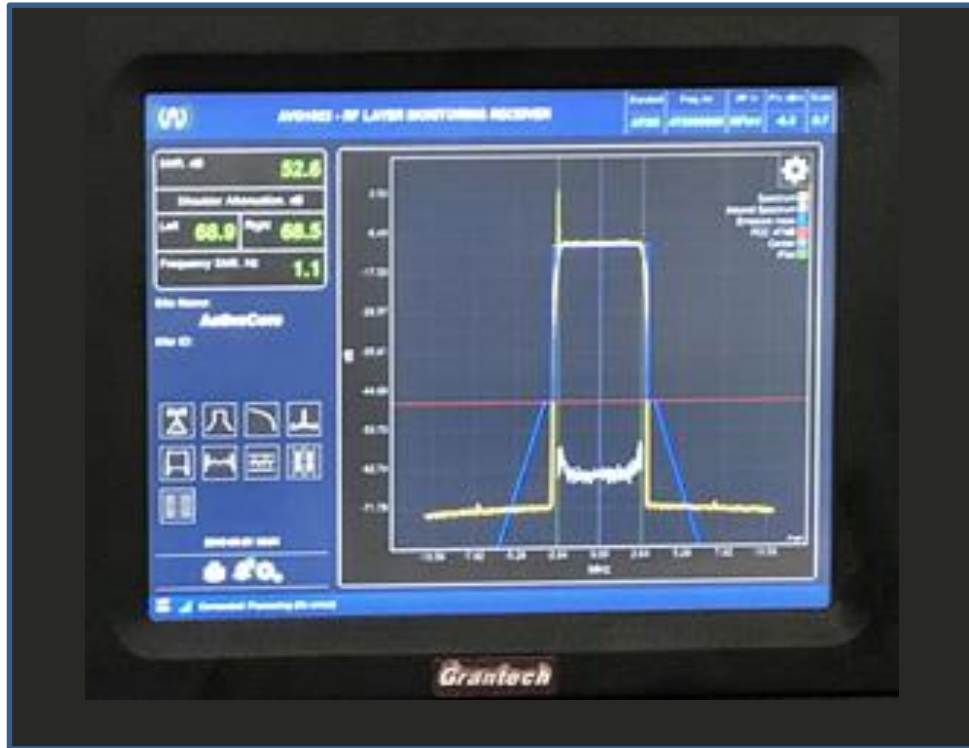

- Real time signal quality monitoring including spectrum, shoulders, constellation diagram, eye diagram, MER, frequency response, impulse response, group delay, CCDF, etc.
- Built-in performance monitoring eliminates the need for costly test equipment
- Upgradable to ATSC3.0



ANYWAVE



Exciter Specifications



Signal Inputs

- TS Inputs: 2 Transport Stream with loop out, DVB-ASI only
Connector: BNC female 75 Ω
- RF Input: Frequency: VHF or UHF
Bandwidth: 6 MHz
Connector: BNC female 50 Ω
Level: -85 dBm ~ -15 dBm
AWGN TOV: ≤ 16 dB (ATSC A/53 operation)
Equalization Range (-1 μ s ~ 0 μ s): ≤ -2 dB
Equalization Range (0 μ s ~ 17 μ s): ≤ -3 dB
Adjacent Channel Rejection ($N \pm 1$): > 30 dB

Signal Processing

- Bandwidth: 6, 7, or 8 MHz
- Supported Modes: ATSC, ATSC 3.0, DVB-T/T2, ISDB-T, DTMB
- Network Mode: MFN, SFN

RF Output

- Connector (RF Out): N-Type female 50 Ω
- Frequency: VHF/UHF in steps of 1 Hz, spectrum shifting up to ± 50 KHz
- Level: -25 dBm ~ +5 dBm in steps of 0.05 dB
- Level Stability: $< \pm 0.1$ dB
- Frequency Stability: $< 0.5 \times 10^{-7}$ (with onboard 10MHz REF), or in accordance with the Ext. GPS accuracy
- Symbol Rate: 10.762238 MHz (ATSC)
- MER: > 40 dB
- Amplitude Flatness: $< \pm 0.5$ dB
- IMD Shoulder Level (± 500 kHz): < -60 dB
- Out of Band Spurious: < -60 dB
- Pilot Amplitude Error: $< \pm 0.1$ dB (ATSC)
- Return Loss: > 15 dB
- Phase Noise (@20 kHz): < -107 dBc/Hz

Reference Clock

Internal 10MHz

- Frequency Stability: $< \pm 0.05$ ppm
- Aging: $< \pm 0.05$ ppm/year
- Output level: 0 dBm ± 3 dB

External 10MHz

- Input Level: AC coupled V (p-p) > 300 mV
- Input Connector: BNC female 50 Ω

External 1PPS

- Input Level: TTL
- Input Connector: BNC female 50 Ω

Linear and Non-linear ADPC™

- Dual Feedback Signal: BNC female 50 Ω
- Feedback level: -35 dBm ~ 0 dBm (suggested value: -15 dBm ~ -5 dBm)
- Correction is Adaptive and Automatic: No additional instruments or manual operations needed
- Continuous measurement and display of SNR and IMD
- Correction of amplitude, phase and group delay
- Up to 10 dB of MER improvement
- Up to 15 dB of shoulder improvement
- In-band flatness: $< \pm 0.5$ dB

Other

- Power Supply: 88 ~ 264 VAC, 50/60Hz
- Operating Temperature: 0° C ~ 50° C (+32°F ~ +122°F)
- Operating Humidity: $\leq 95\%$
- Size: 1 RU, 19" Wide
- Weight: 15 LBS



ANYWAVE



Cooling System



- Cooling system implements 100% redundant, most efficient pumps on the market with all stainless steel pipes
- 100% redundant heat exchanger blowers with individual temp and speed control
- Automatically analyzes system parameters, finds optimum settings and continuously adjusts operation to changes in demand – optimized performance with minimum energy consumption
- Cooling system can be integrated into the same rack for single transmitter with up to five PAs



Magma VHF BAND I & III Specifications (Power ratings before bandpass filter)

HPTV Series - VHF Band III ⁽¹⁾						
Standard	All ⁽²⁾					
Number of amplifiers/rack	1	2	3	4	6	8
Output Power (RMS) KW - ATSC 1.0	2.5	5	7.5	10	15	20
Output Power (RMS) KW - COFDM	2	4	6	8	12	16
Output Power (Peak) Analog	4.6	9.2	13.8	18.4	27.6	35
Output connector	1-5/8"			3-1/8"		
Height (inches/mm)	77.2/1960					
Width (inches/mm)	30/762					
Depth (inches/mm)	56.3/1429					
AC input voltage	208 VAC, 3-phase					
AC input frequency	50/60 Hz					
Consumption - ATSC 1.0 - KW	5.56	11.1	16.7	22.2	33.3	44.4
Current Rating Per ϕ - ATSC 1.0 - A	15.4	30.9	46.3	61.7	92.6	123.5
Consumption - OFDM - KW	4.5	8.9	13.3	17.8	26.7	35.6
Current Rating Per ϕ - OFDM - A	12.3	24.7	37.1	49.4	74.1	98.8
Consumption - Analog (Peak) - KW	7.1	14.2	21.3	28.5	42.7	54.1
Current rating per ϕ - Analog - A	19.7	39.5	59.2	79.1	118.6	150.3

(1) Power levels up to specified value - measured before Band Pass Filter

(2) Standards include ATSC, ATSC 3.0, DVB-T, DVB-T2, ISDB-T, CMMB, DTMB, NTSC, PAL

HPTV Series - VHF Band I ⁽¹⁾				
Standard	All ⁽³⁾			
Number of amplifiers/rack	1	2	4	8
Output Power (RMS) KW - ATSC 1.0 ⁽²⁾	1.9/1.5	3.8/3.0	7.6/6.0	15.2/12.0
Output Power (RMS) KW - COFDM ⁽²⁾	1.25/1.0	2.5/2.0	5.0/4.0	10.0/7.9
Output Power (Peak) Analog ⁽²⁾	4.4/3.5	8.7/6.9	15.0/13.8	35/27.6
Output connector	1-5/8"			3-1/8"
Height (inches/mm)	77.2/1960			
Width (inches/mm)	30/762			
Depth (inches/mm)	56.3/1429			
AC input voltage	208 VAC, 3-phase			
AC input frequency	50/60 Hz			
Consumption - ATSC 1.0 - KW ⁽²⁾	9.5/7.5	19.0/15.0	38.0/30.0	76.0/60.0
Current Rating Per ϕ - ATSC 1.0 - A	26.4/20.9	52.8/41.7	105.6/83.4	211.2/166.8
Consumption - OFDM - KW ⁽²⁾	6.25/4.95	12.6/9.9	25.1/19.8	50.2/39.6
Current Rating Per ϕ - OFDM - A	17.3/13.8	34.9/27.5	69.8/55.0	139.4/110.1
Consumption - Analog (Peak) - KW ⁽²⁾	15.2/12.0	30.4/24.0	52.2/48.0	121.6/96.0
Current rating per ϕ - Analog - A	42.3/33.4	84.5/66.7	145.0/133.4	337.9/267.8

(1) Power measured before Band Pass Filter

(2) Power Levels CH 2,3,4,5,6

(3) Standards include ATSC, ATSC 3.0, DVB-T, DVB-T2, ISDB-T, CMMB, DTMB, NTSC, PAL

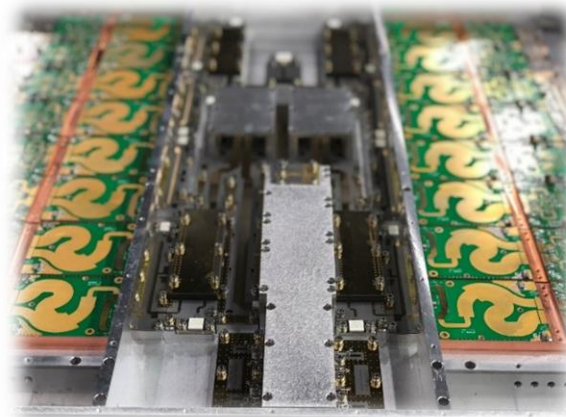

ANYWAVE



General Specifications

Specifications		
Digital TV		
Standards		DVB-T, DVB-T2, ATSC, ATSC3.0, ISDB-T, DTMB
Channel bandwidth	DVB-T	6/7/8 MHz
	DVB-T2	1.7/5/6/7/8 MHz
	ATSC	6 MHz
	ISDB-T	6/8 MHz
	DTMB	8 MHz
Inputs	DVB-T, DVB-T2, DTMB	2 × ASI (HP/LP), 75 Ω BNC, 2 × RJ-45
	ATSC	2 × SMPTE310M or 2 × ASI, 75 Ω BNC, 2 × RJ-45
	ISDB-T/ISDB-T _B	2 × BTS, 75 Ω BNC, 2 × RJ-45
		2 x ETI, BNC 75 Ω/high impedance, 2 x RJ-45
General data		
Frequency range	VHF band I or III	54 MHz to 88 MHz or 174 MHz to 216 MHz 208 V; 3-phase, 4 wire (L1,L2,L3,GND)
Max. installation altitude	> 2000m on request	2000 m above sea level
Operating temperature range		+1 °C to +45 °C
Relative humidity (max.)		95 %, non-condensing
Synchronization - Reference frequency		10 MHz, 0.3 V to 5 V (Vpp) or TTL, BNC
Reference pulse		1 Hz, TTL, BNC
Operation		
Display unit with touchscreen and LEDs		local operation and display
Ethernet interface, RJ-45		local, remote, standard web browser
		network management interface via SNMP
Parallel remote interface		floating contacts for messages and commands

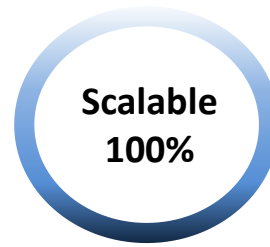

www.anywavecom.net



Anywave Broadcast Inc

Email: sales@anywaveus.com

Phone: +1 (847) 415 2258

Fax: +1 (847) 415 2112

Address: 100 N. Fairway Drive, Suite 130
Vernon Hills, IL 60061

Website: www.anywavecom.net

